

leboulch



www.leboulch.com

COMPLETE RANGE AND PROFESSIONAL SERVICE



**A Century of Experience at Your Service!
Now in France and Worldwide with CE Certification!**

GOLD₂



Folding aluminium ladder, galvanised side mudguards and pre-equipment for optional equipment (side bumper and thermoplastic mudguards).



Document tube with individualised parts book and user manual.

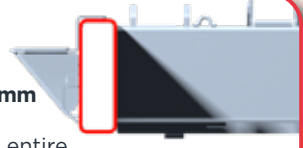

Sturdy 300 x 100 x 10 mm tubular chassis stringer for the entire range, except for 47S16, 53S16 and 53D19 (300 x 100 x 8 mm).

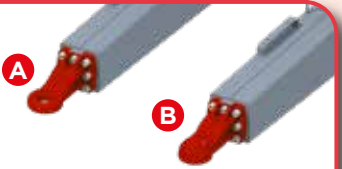

Choice of eyelets
(A) Bolted Ø 50 mm (standard)
(B) Bolted knee-joint (option)



Hydraulic folding parking stand attached directly to the trailer chassis to free the drawbar and facilitate turning.



Noise-reducing silentblock for centering and lateral locking of the body on the chassis.

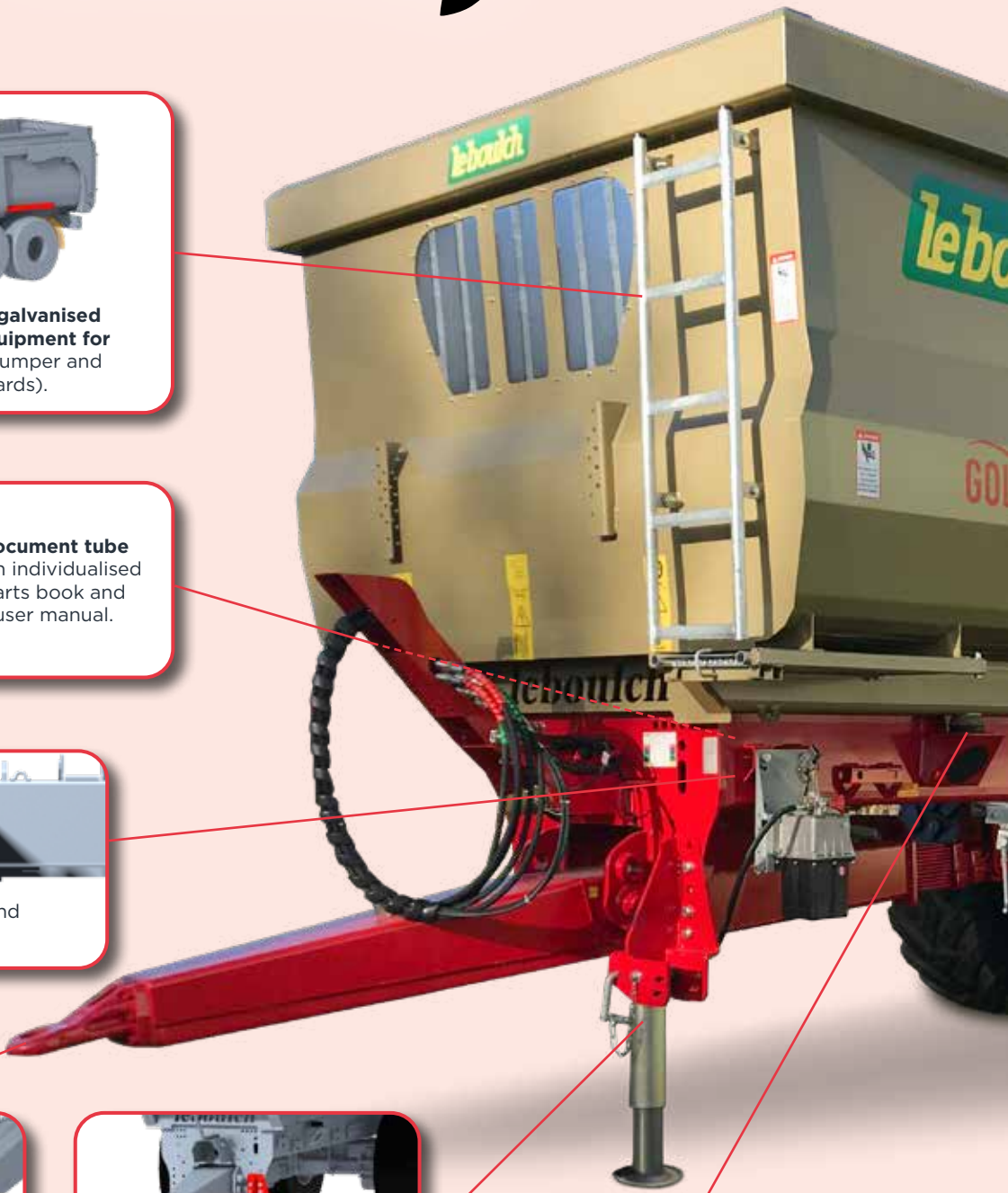

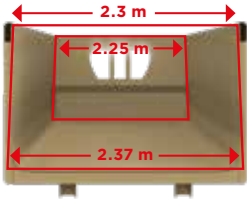

Tapered body (2.25 m at the front and 2.3 m at the rear), wider at the bottom than at the top to facilitate unloading.

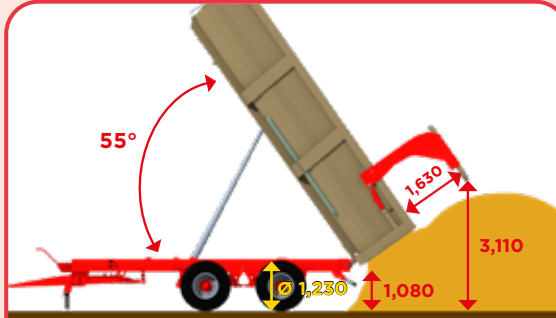

High-clearance rear door with hydraulic opening for easy unloading of silage with extensions and to avoid scraping the pile when tipping at the highest.

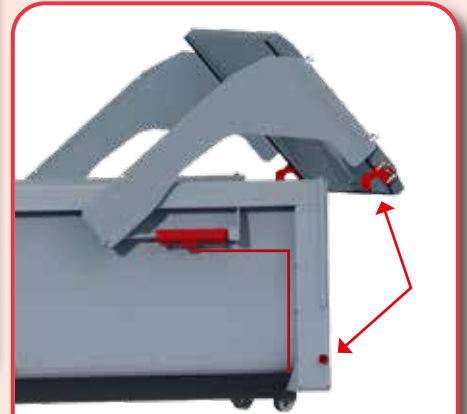

Door opening cylinders protected by the door arms and upper body edge strip.

Double door closing safety system: hydraulic with check valve and mechanical with 2 adjustable hooks. Hydraulic pipes protected by the rear post.



Flexible seal in a rail along the entire height of the door (watertight without grain chute).

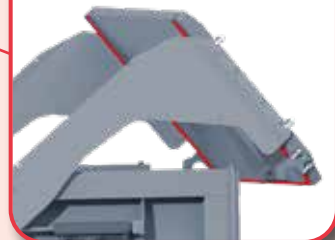

1 or 2 grain hatch(es) with pre-equipment for removable chute.



Bogie suspension with parabolic leaves (on models from 53D19 to 67D24): for improved crossing capacity and load distribution.



Tandem or tridem suspension with parabolic spring leaves and rods (on models from 73D29 to 85T32) for both road and agricultural use.



Galvanised rear bumper with adjustable height and depth.

leboulch

PROFESSIONAL TIPPING TRAILER FOR EVERYONE!





GOLD XL

- ✓ Single or double axle
- ✓ 16 to 24 t
- ✓ Sturdy and reliable

GOLD XXL

- ✓ Double or triple axle
- ✓ 19 to 32 t
- ✓ High resistance to intensive use



OPTIONS

300 mm (steel or aluminium), **500 mm** (aluminium) or **700 mm** (aluminium) extensions, stackable up to 1 m.
2-part side extensions on single- and double-axle models, and 3-part extensions on triple-axle models.



GOLIATH

evolution

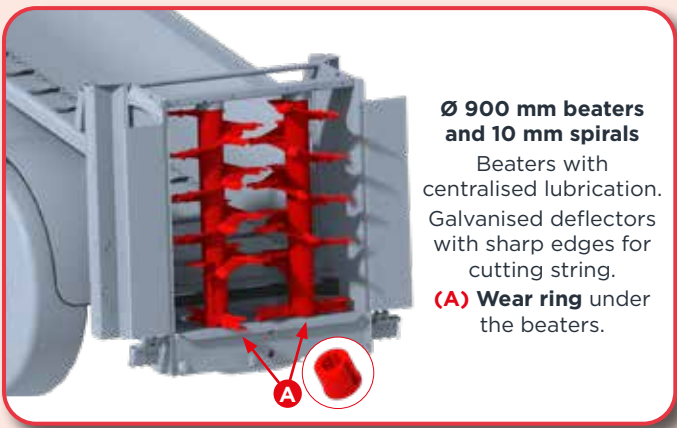
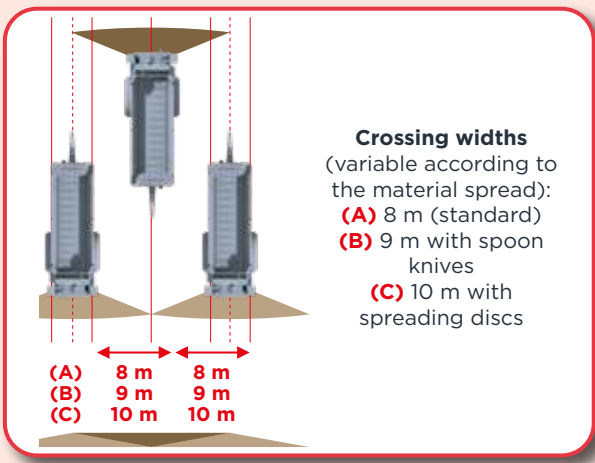



Reversible, interchangeable blades in HARDOX 450

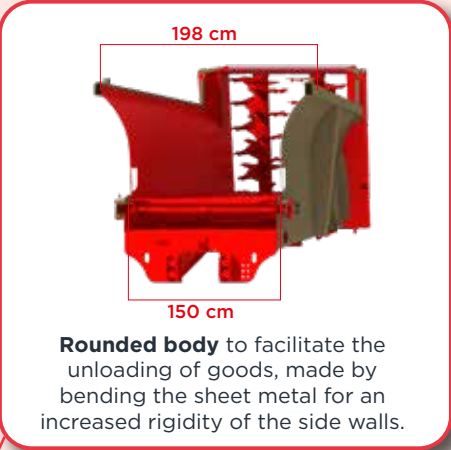

Rounded body to facilitate the unloading of goods, made by bending the sheet metal for an increased rigidity of the side walls.

Simplified DPA with Ferti 500 control box 

Precision DPA with Ferti 4000 control box 

DPA (proportional flow): automatic regulation of the moving floor speed according to the door opening (except Ferti 500) and driving speed.



Digital work counter



Front extension with self-cleaning grate.



Hydraulic installation with electric control, 140 l tank and electrohydraulic system protected under the hood.

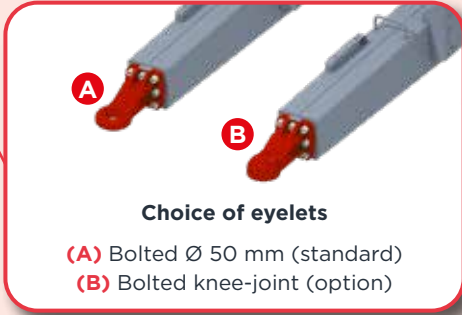

Choice of eyelets

- (A) Bolted Ø 50 mm (standard)
- (B) Bolted knee-joint (option)

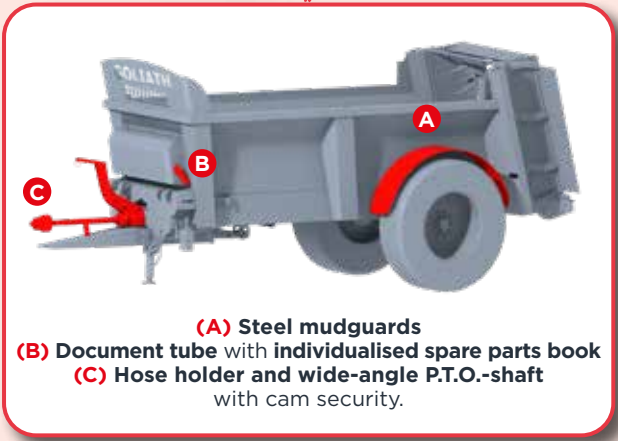

(A) Steel mudguards
 (B) Document tube with individualised spare parts book
 (C) Hose holder and wide-angle P.T.O.-shaft with cam security.



Hydraulic moving floor tensioner with automatic tensioning safety device.

HVS evolution

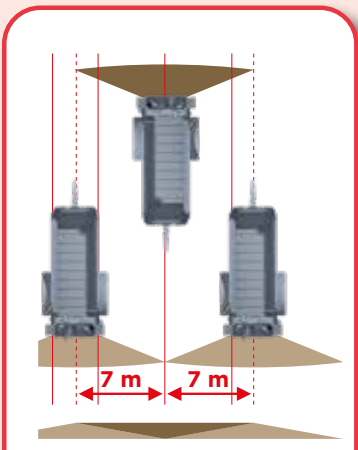
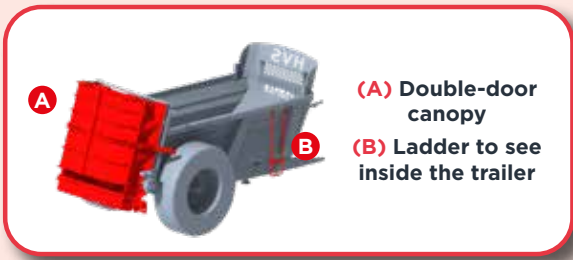
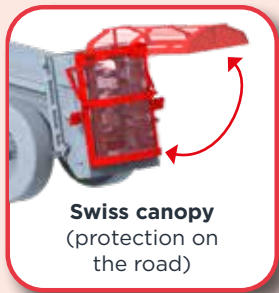

Crossing widths (variable according to the material spread): 7 m (standard) or 8 m with spoon knives.

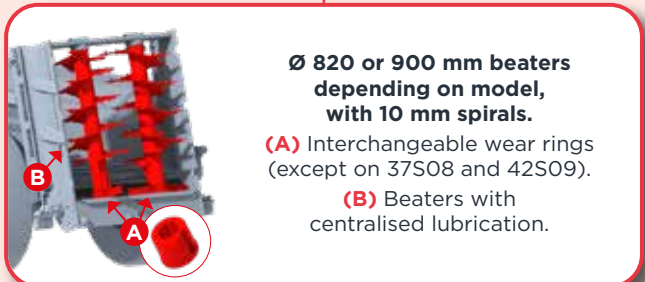
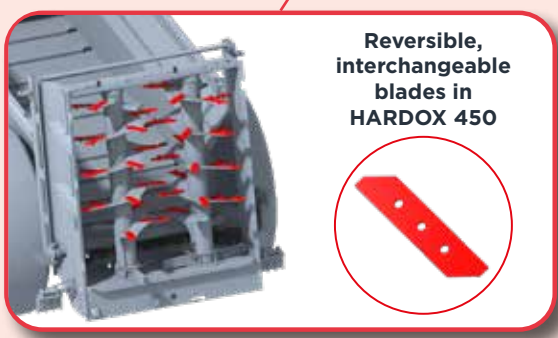



Guillotine door
(standard pre-equipment)

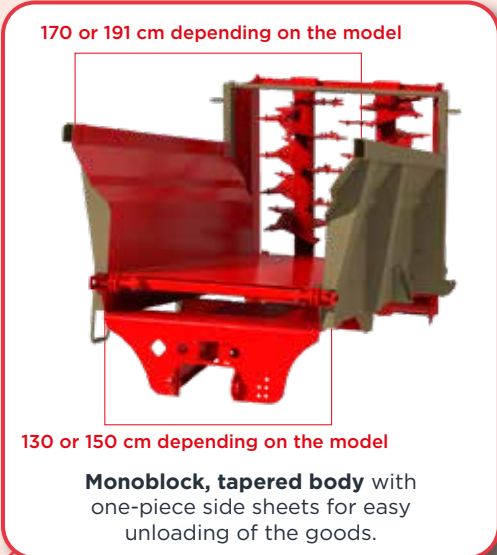

170 or 191 cm depending on the model

130 or 150 cm depending on the model

Monoblock, tapered body with one-piece side sheets for easy unloading of the goods.

Simplified DPA with Ferti 500 control box



Precision DPA with Ferti 4000 control box



DPA (proportional flow): automatic regulation of the moving floor speed according to the door opening (except Ferti 500) and driving speed. Control box to be placed in the tractor.



Front extension with self-cleaning grate.



Document tube with individualised spare parts book.

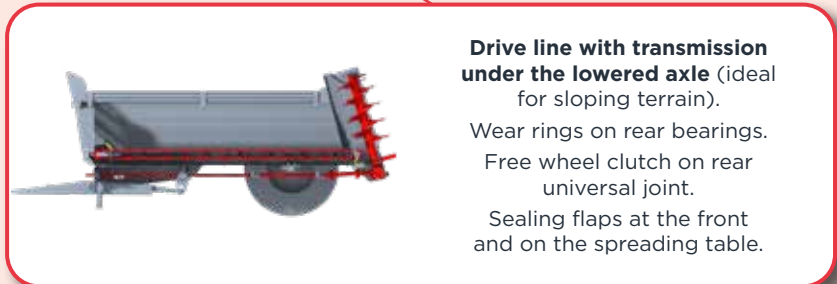

Drive line with transmission under the lowered axle (ideal for sloping terrain).

Wear rings on rear bearings.

Free wheel clutch on rear universal joint.

Sealing flaps at the front and on the spreading table.



Tubular slats welded to shipping chains 14 (to avoid material storage) + mechanically welded gearwheels.



leboulch

GOLIATH
evolution

**PROFESSIONAL
MUCK SPREADER FOR
CONTRACTORS**



HVS
evolution

**ALL-TERRAIN
MOUNTAIN-TYPE
MUCK SPREADER**





GOLIATH evolution

- ✓ A muck spreader that nothing stops!
- ✓ Designed to withstand the toughest working conditions over time

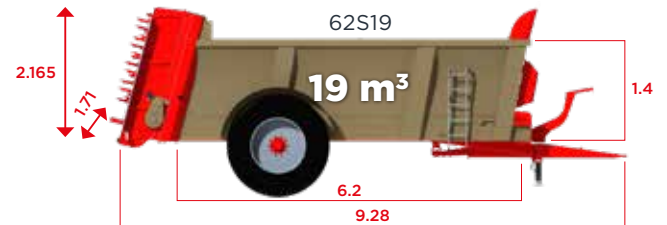
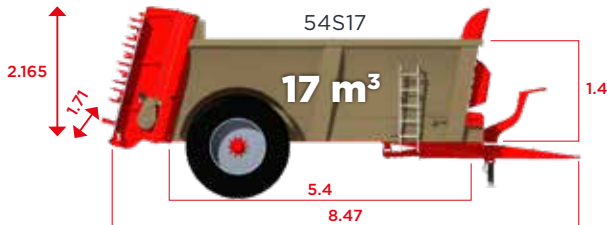
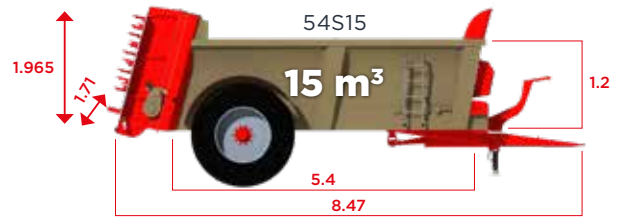
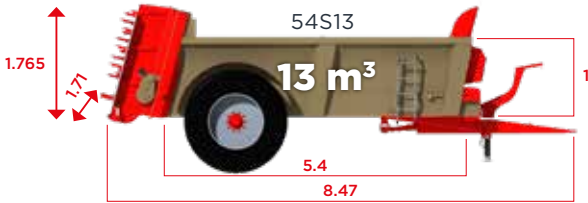
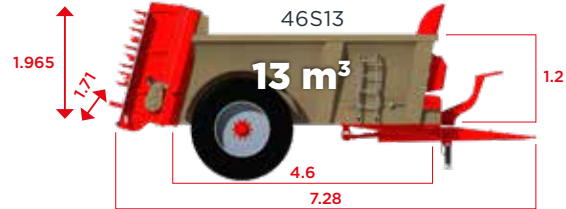
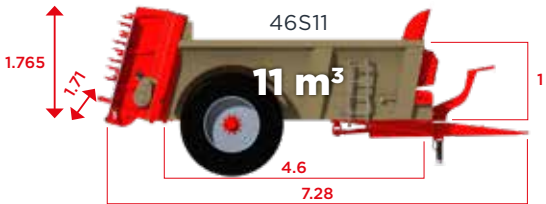

HVS evolution

- ✓ For small and medium-sized businesses
- ✓ Lowered body for excellent stability and grip on slopes
- ✓ Excellent price-quality ratio!

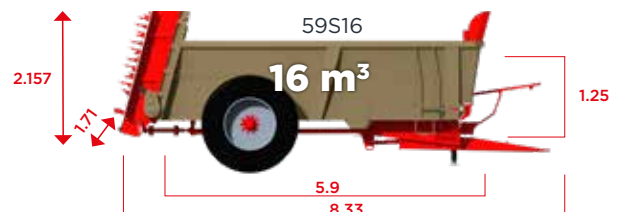
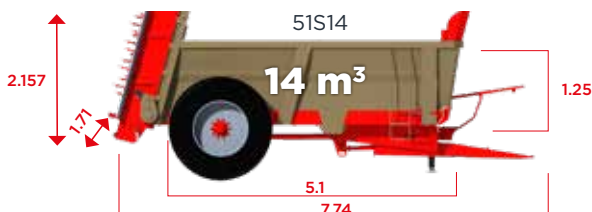
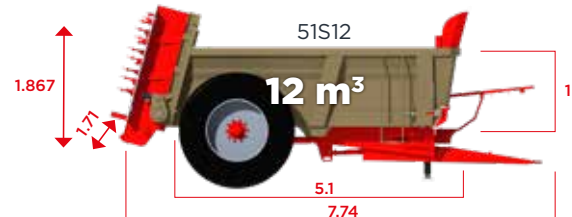
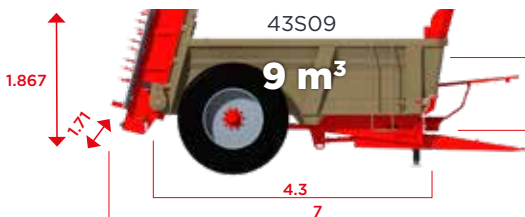
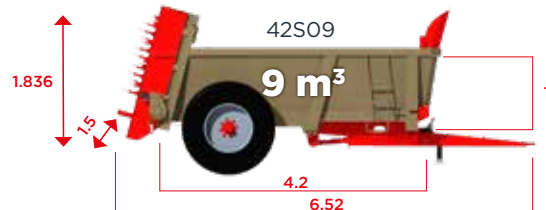
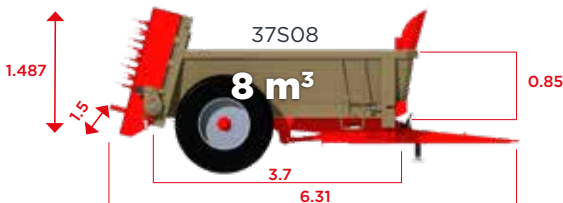

The above dimensions are given in meters (m).



Active in Spreading for Over 100 Years

GOLIATH

evolution

HVS

evolution



leboulch

JLB le Boulch

Route de Guernanville, 27330 La Vieille-Lyre (France)

Tel.: +32 4 377 35 45 • E-mail: info@leboulch.com

www.leboulch.com

Discover our machines in action on YouTube 

